



MIRASOL

MINA

Floor and unit plans



Ground Floor



	R
	17
	16
	15
	14
	13
R	12
	11
	10
	9
	8
	7
	6
	5
	4
	3
	2
	1
M	
G	



- STUDIO
- 1 BEDROOM SUITE
- 3 BEDROOM GARDEN DUPLEX
- 1 BEDROOM PREMIUM

Floor plan numbers, square footage, and floor plans are approximate. Final dimensions, square footage and floor plans may vary or may be mirrored. Balcony area varies depending on location of unit on the floor.

Mezzanine Floor



	R
	17
	16
	15
	14
	13
	12
R	11
11	10
10	9
9	8
8	7
7	6
6	5
5	4
4	3
3	2
2	1
M	
G	



- STUDIO
- 1 BEDROOM PREMIUM
- 1 BEDROOM SUITE
- 3 BEDROOM WATERRONT DUPLEX
- 3 BEDROOM GARDEN DUPLEX

Floor plan numbers, square footage, and floor plans are approximate. Final dimensions, square footage and floor plans may vary or may be mirrored. Balcony area varies depending on location of unit on the floor.

First Floor



	R
	17
	16
	15
	14
	13
	12
R	11
11	11
10	10
9	9
8	8
7	7
6	6
5	5
4	4
3	3
2	2
1	1
M	
G	



- STUDIO
- 1 BEDROOM PREMIUM
- 1 BEDROOM SUITE
- 2 BEDROOM
- 3 BEDROOM GARDEN DUPLEX
- 3 BEDROOM WATERRONT DUPLEX

Floor plan numbers, square footage, and floor plans are approximate. Final dimensions, square footage and floor plans may vary or may be mirrored. Balcony area varies depending on location of unit on the floor.

Level 02-05

TOWER 1,2



	R	
	17	
	16	
	15	
	14	
	13	
	12	
	11	
	10	
	9	
	8	
	7	
	6	
	5	
	4	
	3	
	2	
	1	
M		
G		

TOWER 02

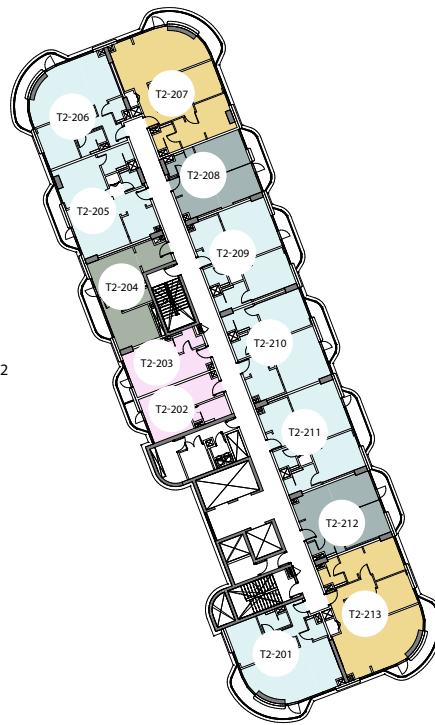

TOWER 01

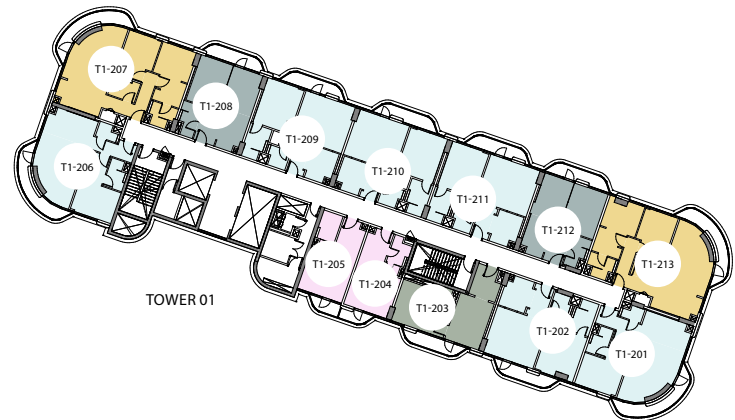

- STUDIO
- 1 BEDROOM PREMIUM
- 1 BEDROOM SUITE
- 2 BEDROOM
- 3 BEDROOM GARDEN DUPLEX

Floor plan numbers, square footage, and floor plans are approximate. Final dimensions, square footage and floor plans may vary or may be mirrored. Balcony area varies depending on location of unit on the floor.

Level 06

TOWER 1,2



	R	
	17	
	16	
	15	
	14	
	13	
	12	
	11	
	10	
	9	
	8	
	7	
	6	
	5	
	4	
	3	
	2	
	1	
M		
G		

TOWER 02

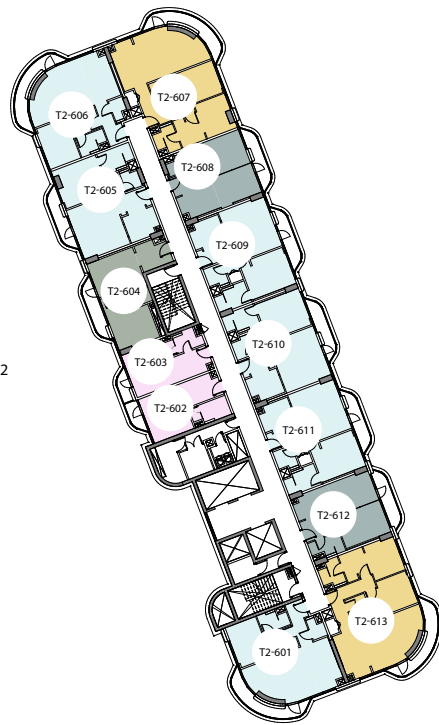

TOWER 01

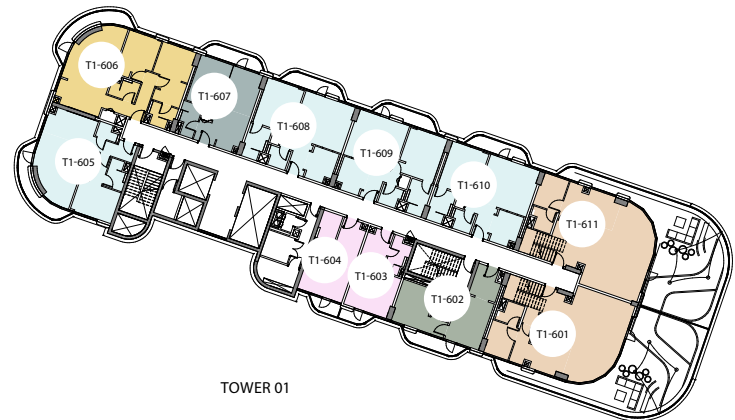

- STUDIO
- 1 BEDROOM PREMIUM
- 1 BEDROOM SUITE
- 2 BEDROOM
- 3 BEDROOM DUPLEX

Floor plan numbers, square footage, and floor plans are approximate. Final dimensions, square footage and floor plans may vary or may be mirrored. Balcony area varies depending on location of unit on the floor.

Level 07

TOWER 1,2



	R	
	17	
	16	
	15	
	14	
	13	
	12	
	11	
	10	
	9	
	8	
	7	
	6	
	5	
	4	
	3	
	2	
	1	
M		
G		

TOWER 02

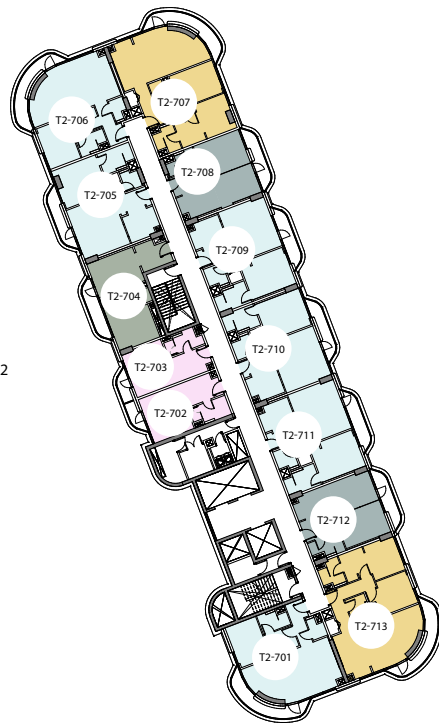

TOWER 01

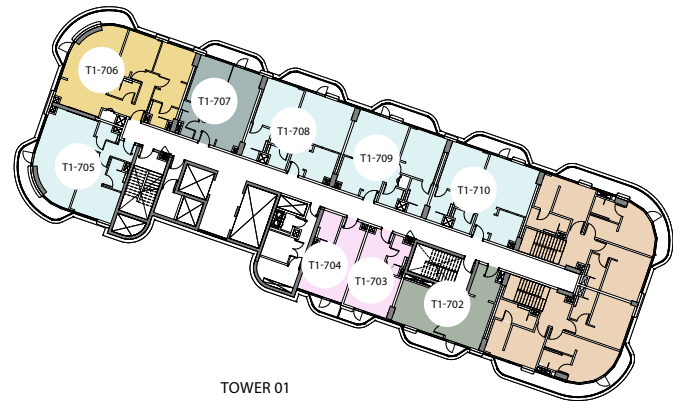

- STUDIO
- 1 BEDROOM SUITE
- 3 BEDROOM DUPLEX
- 1 BEDROOM PREMIUM
- 2 BEDROOM

Floor plan numbers, square footage, and floor plans are approximate. Final dimensions, square footage and floor plans may vary or may be mirrored. Balcony area varies depending on location of unit on the floor.

Level 08

TOWER 1,2



	R	
	17	
	16	
	15	
	14	
	13	
	12	
	11	
	10	
	9	
	8	
	7	
	6	
	5	
	4	
	3	
	2	
	1	
M		
G		

TOWER 02

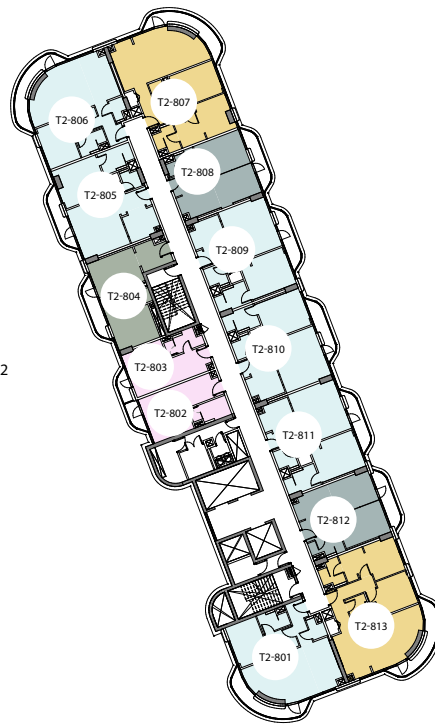

TOWER 01



- STUDIO
- 1 BEDROOM PREMIUM
- 1 BEDROOM SUITE
- 2 BEDROOM
- 3 BEDROOM DUPLEX

Floor plan numbers, square footage, and floor plans are approximate. Final dimensions, square footage and floor plans may vary or may be mirrored. Balcony area varies depending on location of unit on the floor.

Level 09

TOWER 1,2



	R	
	17	
	16	
	15	
	14	
	13	
	12	
	11	
	10	
	9	
	8	
	7	
	6	
	5	
	4	
	3	
	2	
	1	
M		
G		

TOWER 02

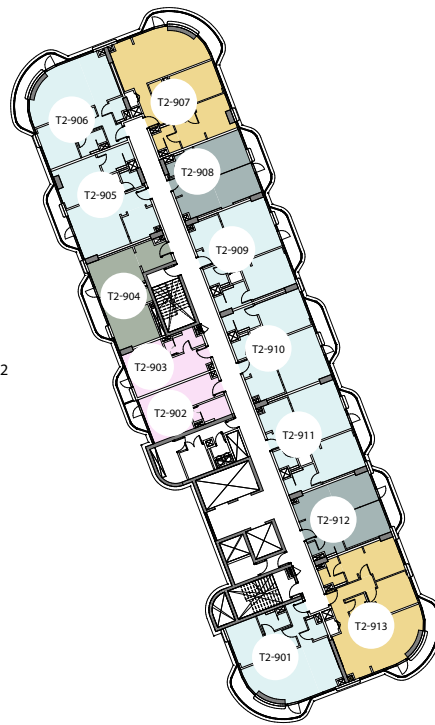

TOWER 01



- STUDIO
- 1 BEDROOM PREMIUM
- 1 BEDROOM SUITE
- 2 BEDROOM
- 3 BEDROOM DUPLEX

Floor plan numbers, square footage, and floor plans are approximate. Final dimensions, square footage and floor plans may vary or may be mirrored. Balcony area varies depending on location of unit on the floor.

Level 10

TOWER 1,2



	R	_____
	17	_____
	16	_____
	15	_____
	14	_____
	13	_____
	12	_____
	11	_____
	10	_____
	9	_____
	8	_____
	7	_____
	6	_____
	5	_____
	4	_____
	3	_____
	2	_____
	1	_____
M		_____
G		_____

TOWER 02

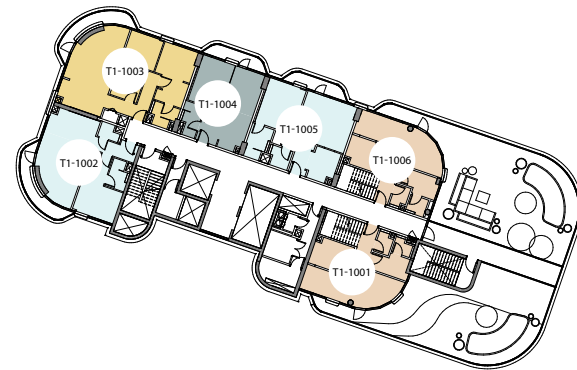
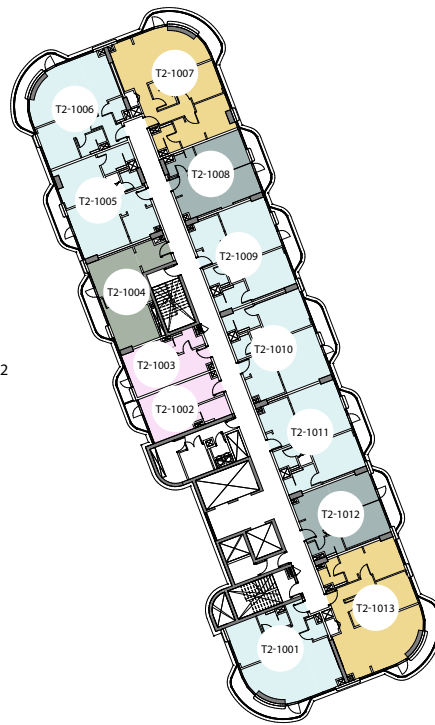

TOWER 01

- STUDIO
- 1 BEDROOM SUITE
- 2 BEDROOM
- 3 BEDROOM DUPLEX
- 1 BEDROOM PREMIUM

Floor plan numbers, square footage, and floor plans are approximate. Final dimensions, square footage and floor plans may vary or may be mirrored. Balcony area varies depending on location of unit on the floor.

Level 11

TOWER 1,2



	R	
	17	
	16	
	15	
	14	
	13	
	12	
	11	
	10	
	9	
	8	
	7	
	6	
	5	
	4	
	3	
	2	
	1	
M		
G		

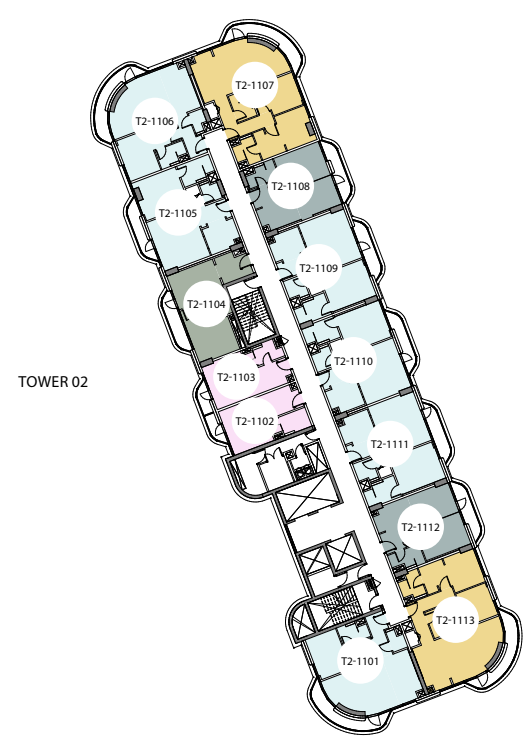

TOWER 02

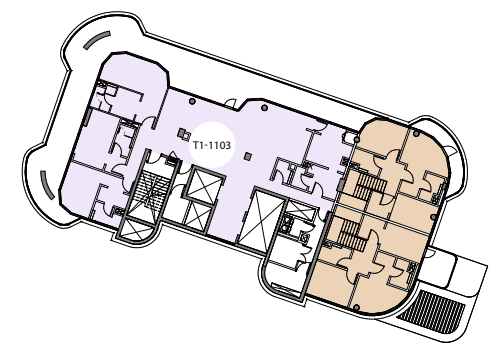

TOWER 01

- STUDIO
- 1 BEDROOM PREMIUM
- 1 BEDROOM SUITE
- 2 BEDROOM
- 3 BEDROOM DUPLEX
- PENTHOUSE

Floor plan numbers, square footage, and floor plans are approximate. Final dimensions, square footage and floor plans may vary or may be mirrored. Balcony area varies depending on location of unit on the floor.

Level 12

TOWER 2



	R	_____
	17	_____
	16	_____
	15	_____
	14	_____
	13	_____
	12	_____
	11	_____
	10	_____
	9	_____
	8	_____
	7	_____
	6	_____
	5	_____
	4	_____
	3	_____
	2	_____
	1	_____
M		_____
G		_____

TOWER 02

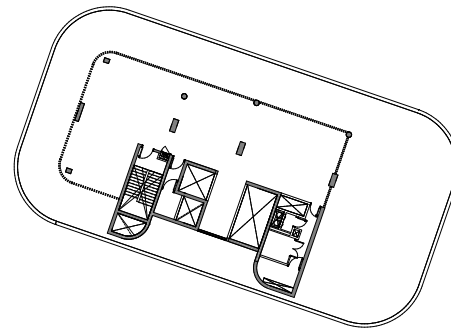

TOWER 01

- STUDIO
- 1 BEDROOM SUITE
- 3 BEDROOM DUPLEX
- 1 BEDROOM PREMIUM
- 2 BEDROOM

Floor plan numbers, square footage, and floor plans are approximate. Final dimensions, square footage and floor plans may vary or may be mirrored. Balcony area varies depending on location of unit on the floor.

Level 13

TOWER 02



	R	17
		16
		15
		14
		13
R		12
11		11
10		10
9		9
8		8
7		7
6		6
5		5
4		4
3		3
2		2
1		1
M		
G		

TOWER 02

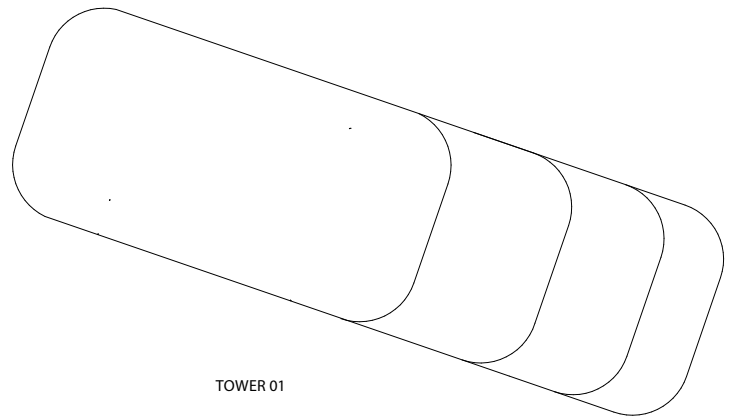

TOWER 01

- STUDIO
- 1 BEDROOM PREMIUM
- 1 BEDROOM SUITE
- 2 BEDROOM
- 3 BEDROOM DUPLEX

Floor plan numbers, square footage, and floor plans are approximate. Final dimensions, square footage and floor plans may vary or may be mirrored. Balcony area varies depending on location of unit on the floor.

Level 14

TOWER 2



	R	
	17	
	16	
	15	
	14	
	13	
R	12	
11	11	
10	10	
9	9	
8	8	
7	7	
6	6	
5	5	
4	4	
3	3	
2	2	
1	1	
M		
G		

TOWER 02

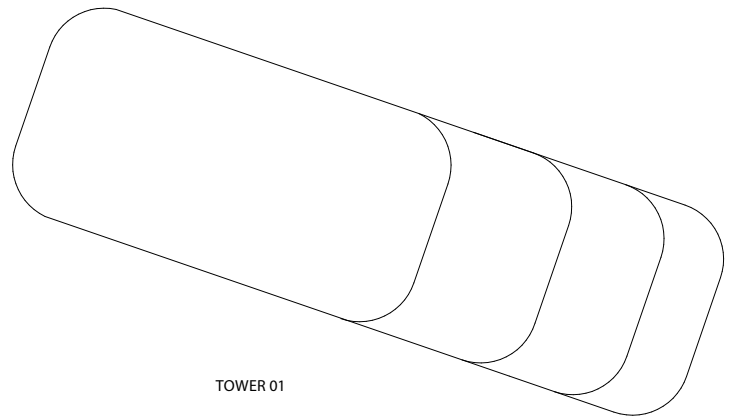

TOWER 01

- STUDIO
- 1 BEDROOM SUITE
- 1 BEDROOM PREMIUM
- 2 BEDROOM
- 3 BEDROOM DUPLEX

Floor plan numbers, square footage, and floor plans are approximate. Final dimensions, square footage and floor plans may vary or may be mirrored. Balcony area varies depending on location of unit on the floor.

Level 15

TOWER 2



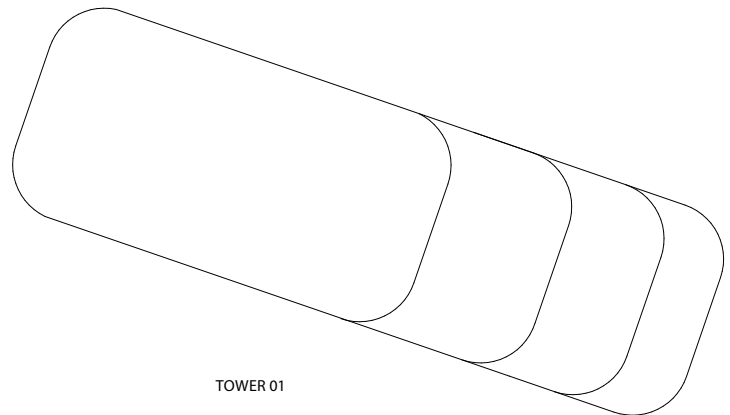

	R	
	17	
	16	
	15	
	14	
	13	
	12	
R	11	
11	11	
10	10	
9	9	
8	8	
7	7	
6	6	
5	5	
4	4	
3	3	
2	2	
1	1	
M		
G		

TOWER 02



TOWER 01

-  STUDIO
-  1 BEDROOM SUITE
-  3 BEDROOM DUPLEX
-  1 BEDROOM PREMIUM
-  2 BEDROOM

Floor plan numbers, square footage, and floor plans are approximate. Final dimensions, square footage and floor plans may vary or may be mirrored. Balcony area varies depending on location of unit on the floor.

Level 16

TOWER 2



	R	
	17	
	16	
	15	
	14	
	13	
	12	
R	11	
11	10	
10	9	
9	8	
8	7	
7	6	
6	5	
5	4	
4	3	
3	2	
2	1	
1		
M		
G		

TOWER 02

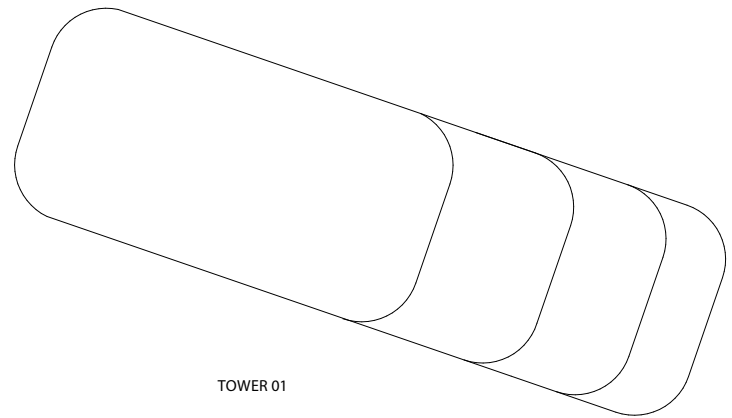
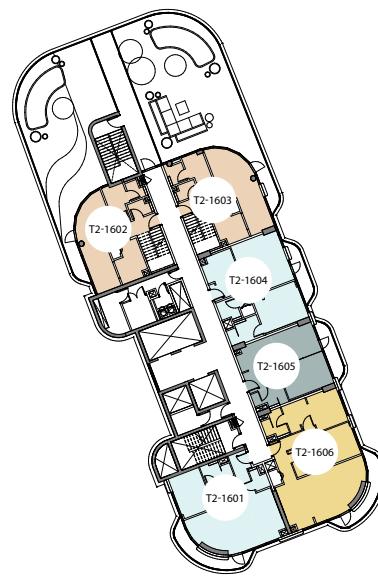

TOWER 01

- STUDIO
- 1 BEDROOM SUITE
- 2 BEDROOM
- 3 BEDROOM DUPLEX
- 1 BEDROOM PREMIUM

Floor plan numbers, square footage, and floor plans are approximate. Final dimensions, square footage and floor plans may vary or may be mirrored. Balcony area varies depending on location of unit on the floor.

Level 17

TOWER 2



	R
	17
	16
	15
	14
	13
	12
R	11
11	10
10	9
9	8
8	7
7	6
6	5
5	4
4	3
3	2
2	1
1	
M	
G	

TOWER 02

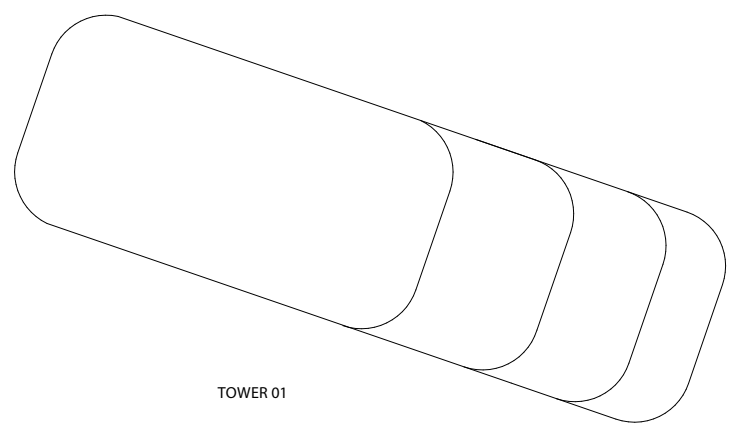
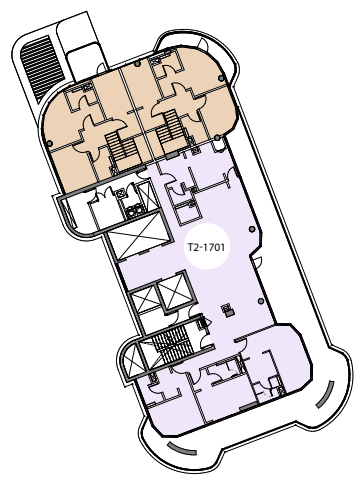

TOWER 01

-  3 BEDROOM DUPLEX
-  PENTHOUSE

Floor plan numbers, square footage, and floor plans are approximate. Final dimensions, square footage and floor plans may vary or may be mirrored. Balcony area varies depending on location of unit on the floor.

Studio

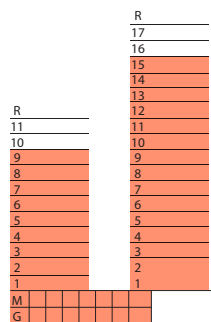

AREAS	SQ.F		SQ.M	
	Min	Max	Min	Max
Internal Area	348.8	361.7	32.4	33.6
External Area	31.1	170.3	2.9	15.8
Total	387.0	532.0	36.0	49.4

LEVELS	UNIT
GROUND FLOOR	25
MEZZANINE FLOOR	25,26
TOWER 01	
L01	122,123,132
L02 TO L05	04,05
L06,L07	03,04
L08,L09	02,03
TOWER 02	
L01	111,112,115
L02 TO L15	02,03

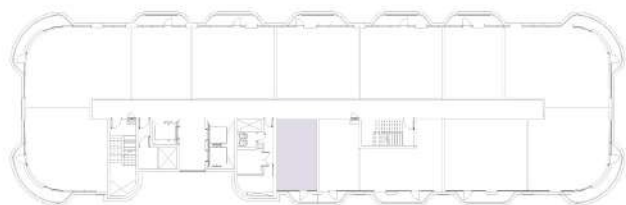

Floor plan numbers, square footage, and floor plans are approximate. Final dimensions, square footage and floor plans may vary or may be mirrored. Balcony area varies depending on location of unit on the floor.

1 BEDROOM SUITE

L-SHAPE

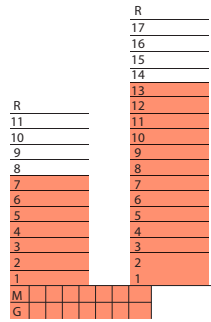

AREAS	SQ.F		SQ.M	
	Min	Max	Min	Max
Internal Area	504.4	517.2	46.9	48.0
External Area	44.1	79.7	4.1	7.4
Total	548.0	590	50.9	54.9

LEVELS	UNIT
GROUND FLOOR	24
MEZZANINE FLOOR	24
TOWER 01	
L01	124
L02 TO L05	03
L06 TO L07	02
TOWER 02	
L01	110
L02 TO L13	04

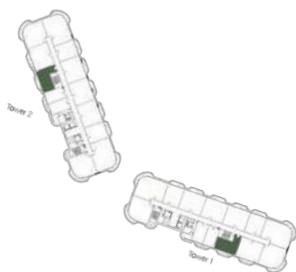

Floor plan numbers, square footage, and floor plans are approximate. Final dimensions, square footage and floor plans may vary or may be mirrored. Balcony area varies depending on location of unit on the floor.

1 BEDROOM SUITE



AREAS	SQ.F		SQ.M	
	Min	Max	Min	Max
Internal Area	523.2	529.6	48.6	49.2
External Area	73.6	234.3	6.8	21.8
Total	600.0	757.6	55.7	70.4

LEVELS	UNIT
TOWER 01	
L01	128
L02 TO L05	08,12
L06 TO L07	07
L08 TO L09	06
L10	04
TOWER 02	
L01	119
L02 TO L11	08,12
L12 TO L13	10
L14 TO L15	08
L16	05

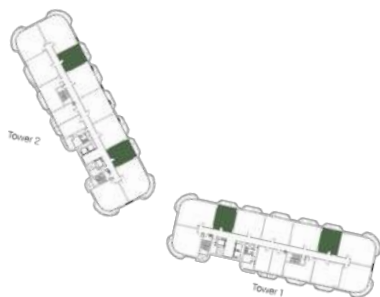

Floor plan numbers, square footage, and floor plans are approximate. Final dimensions, square footage and floor plans may vary or may be mirrored. Balcony area varies depending on location of unit on the floor.

1 BEDROOM PREMIUM

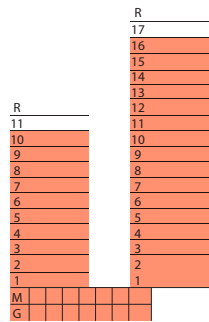

AREAS	SQ.F		SQ.M	
	Min	Max	Min	Max
Internal Area	717.7	737.2	66.7	68.5
External Area	41.0	336.2	3.8	31.2
Total	776.0	1065.9	72.1	99.0

LEVELS	UNIT
GROUND FLOOR	23
MEZZANINE FLOOR	23
TOWER 01	
L01	125,129,130,131
L02 TO L05	02,09,10,11
L06,07	08,09,10
L08,09	07,08
L10	05
TOWER 02	
L01	109,116,117,118
L02 TO L11	05,09,10,11
L12 TO L13	07,08,09
L14 TO L15	06,07
L16	04



Floor plan numbers, square footage, and floor plans are approximate. Final dimensions, square footage and floor plans may vary or may be mirrored. Balcony area varies depending on location of unit on the floor.

I BEDROOM PREMIUM

CORNER



AREAS	SQ.F		SQ.M	
	Min	Max	Min	Max
Internal Area	749.8	807.0	69.7	75.0
External Area	117.0	644.5	10.9	59.9
Total	901.9	1418.2	83.8	131.8

LEVELS	COUNT
GROUND FLOOR	14,21,22
MEZZANINE FLOOR	14,21,22
TOWER 01	
L01	121,126
L02 TO L05	01,06
L06 TO L07	05
L08 TO L09	04
L10	02
TOWER 02	
L01	108,113
L02 TO L11	01,06
L12 TO L16	01

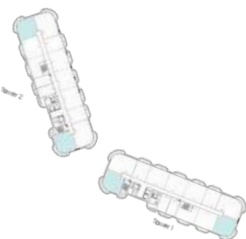

Floor plan numbers, square footage, and floor plans are approximate. Final dimensions, square footage and floor plans may vary or may be mirrored. Balcony area varies depending on location of unit on the floor.

1 BEDROOM CHALET

GROUND

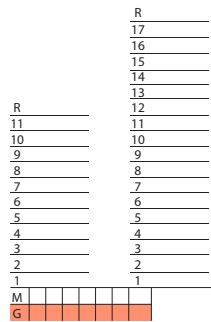

AREAS	SQ.F		SQ.M	
	Min	Max	Min	Max
Internal Area	729.8	740.9	67.8	68.8
External Area	51.9	360.5	4.8	33.5
Total	781.7	1093.9	72.6	101.6

LEVELS	COUNT
GROUND	FROM 01:13

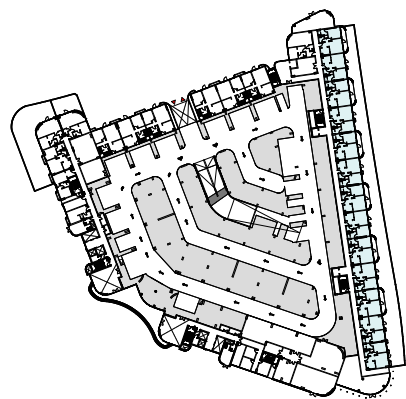

Floor plan numbers, square footage, and floor plans are approximate. Final dimensions, square footage and floor plans may vary or may be mirrored. Balcony area varies depending on location of unit on the floor.

1 BEDROOM CHALET

Mezzanine

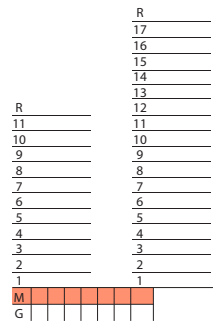

AREAS	SQ.F		SQ.M	
	Min	Max	Min	Max
Internal Area	729.8	740.9	67.8	68.8
External Area	51.9	360.5	4.8	33.5
Total	781.7	1093.9	72.6	101.6

LEVELS	UNIT
MEZZANINE	01,02,04,06,08,10,12



Floor plan numbers, square footage, and floor plans are approximate. Final dimensions, square footage and floor plans may vary or may be mirrored. Balcony area varies depending on location of unit on the floor.

2 BEDROOM



AREAS	SQ.F		SQ.M	
	Min	Max	Min	Max
Internal Area	958.2	970.3	89.0	90.1
External Area	116.8	462.9	10.9	43.0
Total	1081.6	1421.1	100.5	132.0

LEVELS	UNIT
TOWER 01	
L01	120,127
L02 TO L05	07,13
L06 TO L07	06
L08 TO L09	05
L10	03
TOWER 02	
L01	107,114
L02 TO L11	07,13
L12 TO L13	11
L14 TO L15	09
L16	06

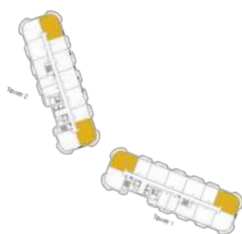
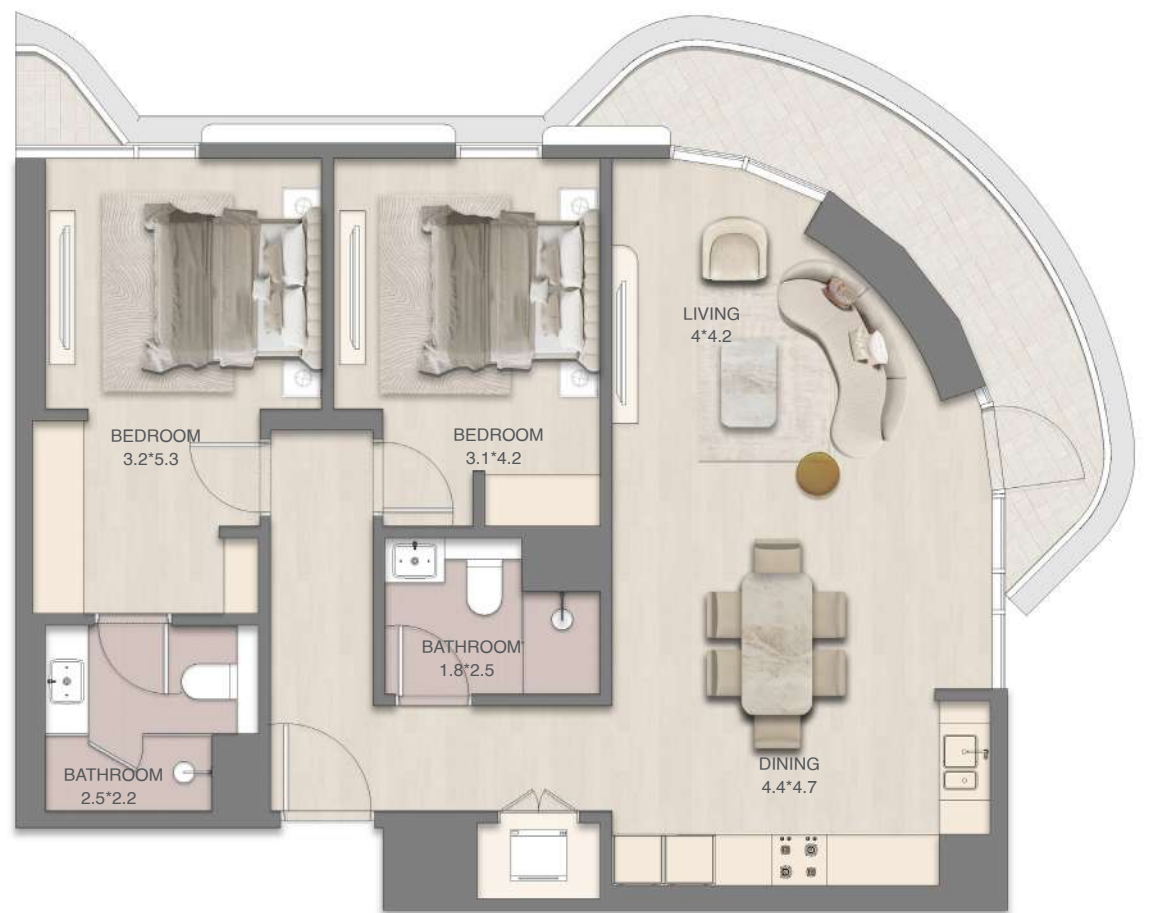

Floor plan numbers, square footage, and floor plans are approximate. Final dimensions, square footage and floor plans may vary or may be mirrored. Balcony area varies depending on location of unit on the floor.

3 BDR DUPLEX

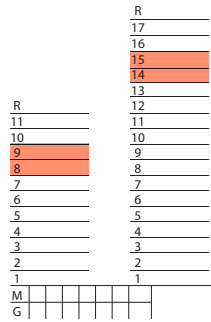

AREAS	SQ.F		SQ.M	
	Min	Max	Min	Max
Internal Area	1511.2	2058.2	140.4	191.2
External Area	1,066.40	1,569.60	99.1	145.8
Total	2776.1	3343.1	257.9	310.6

LEVELS	UNIT
TOWER 01	
L08	09
TOWER 02	
L14	05



LOWER LEVEL



UPPER LEVEL



Floor plan numbers, square footage, and floor plans are approximate. Final dimensions, square footage and floor plans may vary or may be mirrored. Balcony area varies depending on location of unit on the floor.

3 BDR DUPLEX

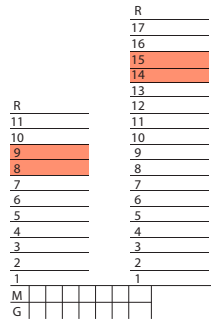

AREAS	SQ.F		SQ.M	
	Min	Max	Min	Max
Internal Area	1511.2	2058.2	140.4	191.2
External Area	1,066.40	1,569.60	99.1	145.8
Total	2776.1	3343.1	257.9	310.6

LEVELS	UNIT
TOWER 01	
L08	01
TOWER 02	
L14	04



LOWER LEVEL



UPPER LEVEL



Floor plan numbers, square footage, and floor plans are approximate. Final dimensions, square footage and floor plans may vary or may be mirrored. Balcony area varies depending on location of unit on the floor.

3 BDR DUPLEX

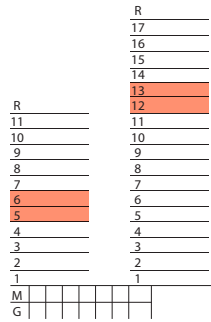

AREAS	SQ.F		SQ.M	
	Min	Max	Min	Max
Internal Area	1511.2	2058.2	140.4	191.2
External Area	1,066.40	1,569.60	99.1	145.8
Total	2776.1	3343.1	257.9	310.6

LEVELS	COUNT
TOWER 01	
L06	01,11
TOWER 02	
L12	05,06



LOWER LEVEL



UPPER LEVEL

Floor plan numbers, square footage, and floor plans are approximate. Final dimensions, square footage and floor plans may vary or may be mirrored. Balcony area varies depending on location of unit on the floor.

3 BDR DUPLEX

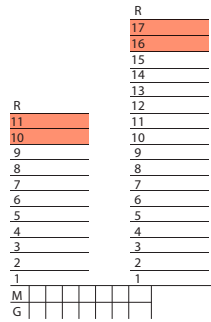

AREAS	SQ.F		SQ.M	
	Min	Max	Min	Max
Internal Area	1511.2	2058.2	140.4	191.2
External Area	1,066.40	1,569.60	99.1	145.8
Total	2776.1	3343.1	257.9	310.6

LEVELS	COUNT
TOWER 01	
L10	01,06
TOWER 02	
L16	02,03



LOWER LEVEL



UPPER LEVEL



Floor plan numbers, square footage, and floor plans are approximate. Final dimensions, square footage and floor plans may vary or may be mirrored. Balcony area varies depending on location of unit on the floor.

3 BDR GARDEN DUPLEX

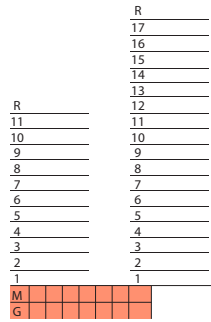

AREAS	SQ.F		SQ.M	
	Min	Max	Min	Max
Internal Area	1783.5	1804.4	165.7	167.6
External Area	308.00	309.50	28.6	28.8
Total	2091.4	2112.3	194.3	196.2

LEVELS	UNIT
GROUND FLOOR	15,16,17,18,19,20



LOWER LEVEL

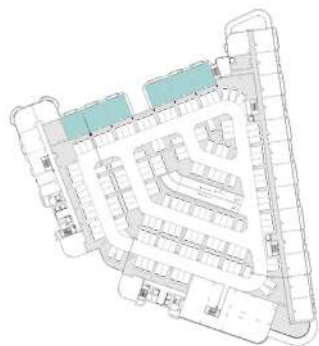

Floor plan numbers, square footage, and floor plans are approximate. Final dimensions, square footage and floor plans may vary or may be mirrored. Balcony area varies depending on location of unit on the floor.

3 BDR GARDEN DUPLEX

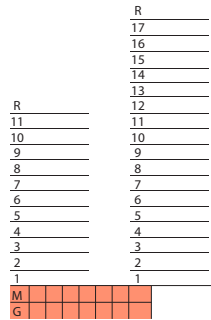

AREAS	SQ.F		SQ.M	
	Min	Max	Min	Max
Internal Area	1783.5	1804.4	165.7	167.6
External Area	308.00	309.50	28.6	28.8
Total	2091.4	2112.3	194.3	196.2

LEVELS	UNIT
GROUND FLOOR	15,16,17,18,19,20



UPPER LEVEL

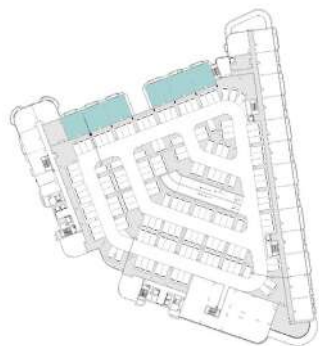

Floor plan numbers, square footage, and floor plans are approximate. Final dimensions, square footage and floor plans may vary or may be mirrored. Balcony area varies depending on location of unit on the floor.

3 BDR WATERFRONT DUPLEX

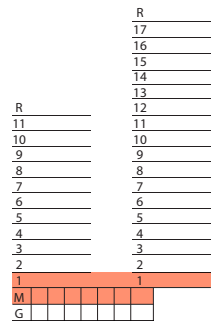

AREAS	SQ.F		SQ.M	
	Min	Max	Min	Max
Internal Area	1617.8	1629.1	150.3	151.3
External Area	639.80	640.40	59.4	59.5
Total	2258.2	2268.9	209.8	210.8

LEVELS	UNIT
MEZZANINE FLOOR	03,05,07,09,11,13



LOWER LEVEL

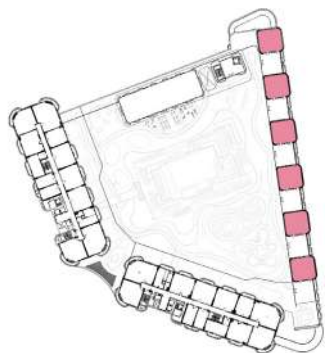

Floor plan numbers, square footage, and floor plans are approximate. Final dimensions, square footage and floor plans may vary or may be mirrored. Balcony area varies depending on location of unit on the floor.

3 BDR WATERFRONT DUPLEX



UPPER LEVEL

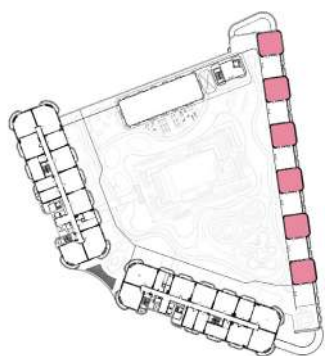

AREAS	SQ.F		SQ.M	
	Min	Max	Min	Max
Internal Area	1617.8	1629.1	150.3	151.3
External Area	639.80	640.40	59.4	59.5
Total	2258.2	2268.9	209.8	210.8

LEVELS	UNIT
MEZZANINE FLOOR	03,05,07,09,11,13

	17
	16
	15
	14
	13
	12
R	
11	11
10	10
9	9
8	8
7	7
6	6
5	5
4	4
3	3
2	2
1	1
M	
G	

PENTHOUSE

	R
	17
	16
	15
	14
	13
	12
R	11
11	10
10	9
9	8
8	7
7	6
6	5
5	4
4	3
3	2
2	1
1	
M	
G	

AREAS	SQ.F		SQ.M	
	Min	Max	Min	Max
Internal Area	2537.9	2547.3	235.8	236.6
External Area	1.372.40	1.378.20	127.5	128.0
Total	3910.3	3925.5	363.3	364.7

LEVELS	COUNT
TOWER 01	
L11	03
TOWER 02	
L17	01

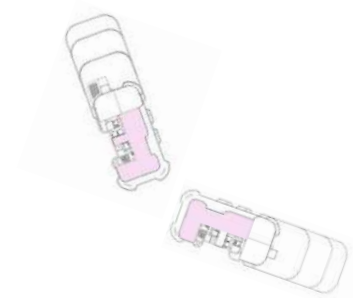

Floor plan numbers, square footage, and floor plans are approximate. Final dimensions, square footage and floor plans may vary or may be mirrored. Balcony area varies depending on location of unit on the floor.



MIRASOL

MINA

THANK YOU

